

# Linear guide rail

# LFS-12-1

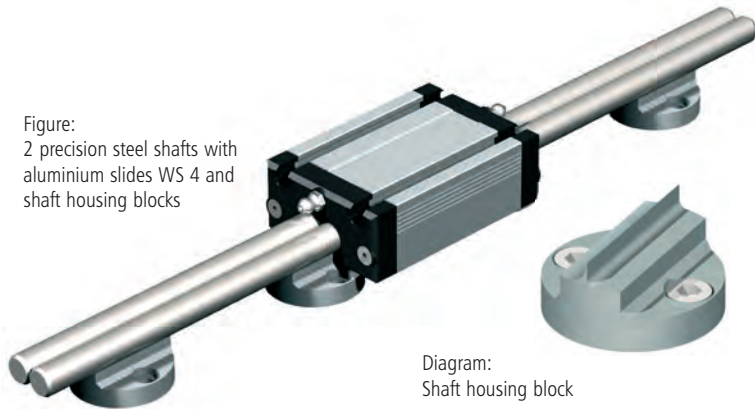

Figure:  
2 precision steel shafts with aluminium slides WS 4 and shaft housing blocks

Diagram:  
Shaft housing block

## Features

- W 40 × H 27 mm
- 2 precision steel shafts Ø 12
- anti-twist
- Aluminium shaft housing blocks
- Securing from above or below with M6 drillings in the housing blocks
- Guide any length up to 3m
- Special lengths to order
- Weight: appr. 1.9 kg/m

## Ordering key

**227 312 XXXX**

Length in mm (in 100 mm raster)  
e.g. **0298** = Length 298  
**2998** = Length 2998

Special lengths to order

**N.B.!**

The part no. refers to one steel shaft only

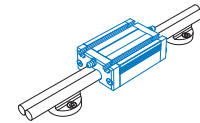

### Aluminium slides

- Clamping surface plane milled
- Weight: appr. 0.3 kg
- Option: stainless design

L 94 x W 62 x H 31.5 mm (WS 4/70)

Part no.: **223104 0070**

stainless steel: **223104 1070**

L 124 x W 62 x H 31.5 mm (WS 4)

Part no.: **223104**

Stainless: **223104 1000**

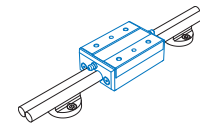

## Load data

Shaft slide WS 4/70		Shaft slide WS 4		Steel slide LS 1		Carriage LW 8	
C <sub>0</sub>	3003 N	C <sub>0</sub>	4868 N	C <sub>0</sub>	3508 N	C <sub>0</sub>	2160 N
C	1873 N	C	2426 N	C	2105 N	C	4000 N
F <sub>1</sub> stat.	2821 N	F <sub>1</sub> stat.	4157 N	F <sub>1</sub> stat.	3549 N	F <sub>1</sub> stat.	4320 N
F <sub>1</sub> dyn.	1599 N	F <sub>1</sub> dyn.	2071 N	F <sub>1</sub> dyn.	2130 N	F <sub>1</sub> dyn.	3846 N
F <sub>2</sub> stat.	3303 N	F <sub>2</sub> stat.	4868 N	F <sub>2</sub> stat.	3508 N	F <sub>2</sub> stat.	2160 N
F <sub>2</sub> dyn.	1873 N	F <sub>2</sub> dyn.	2426 N	F <sub>2</sub> dyn.	2105 N	F <sub>2</sub> dyn.	4000 N
M <sub>x</sub> stat.	29.8 Nm	M <sub>x</sub> stat.	43.9 Nm	M <sub>x</sub> stat.	36.2 Nm	M <sub>x</sub> stat.	109.5 Nm
M <sub>y</sub> stat.	105.3 Nm	M <sub>y</sub> stat.	155.2 Nm	M <sub>y</sub> stat.	129.0 Nm	M <sub>y</sub> stat.	194.4 Nm
M <sub>z</sub> stat.	123.3 Nm	M <sub>z</sub> stat.	181.7 Nm	M <sub>z</sub> stat.	127.5 Nm	M <sub>z</sub> stat.	97.2 Nm
M <sub>x</sub> dyn.	16.8 Nm	M <sub>x</sub> dyn.	21.8 Nm	M <sub>x</sub> dyn.	21.7 Nm	M <sub>x</sub> dyn.	97.4 Nm
M <sub>y</sub> dyn.	59.7 Nm	M <sub>y</sub> dyn.	77.3 Nm	M <sub>y</sub> dyn.	77.4 Nm	M <sub>y</sub> dyn.	173.0 Nm
M <sub>z</sub> dyn.	69.9 Nm	M <sub>z</sub> dyn.	90.5 Nm	M <sub>z</sub> dyn.	76.5 Nm	M <sub>z</sub> dyn.	180.0 Nm

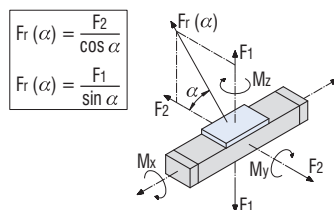

### Steel slide LS 1

L 91 × W 60 × H 32 mm

- Clamping surface ground
- Weight: appr. 0.8 kg

Part no.: **223006**

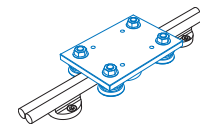

### Carriage LW 3

L 125 × W 85 × H 7.7 mm

- ground steel plate
- Weight: appr. 0.9 kg

Part no.: **223008**

### Shaft housing blocks

- Ø 40 mm, hole spacing 28 mm
- Cast zinc, VE 10 units

Part no.: **221501**

# Linear guide rail

# LFS-12-1

## Dimensioned drawings

LFS-12-1 with Carriage LW 3

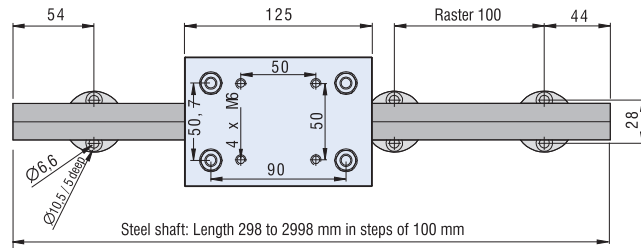
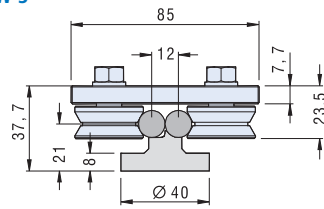

LFS-12-1 with shaft slide WS 4/70 or WS 4

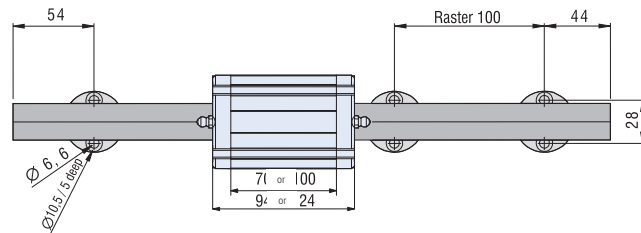
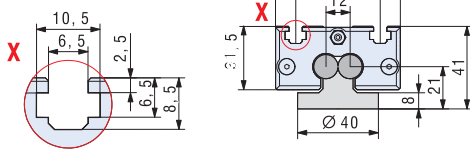

LFS-12-1 with steel slide LS 1

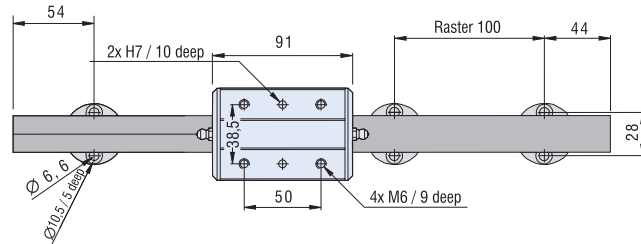
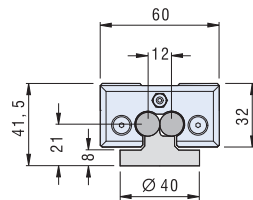

Shaft housing block

